

FICHE TECHNIQUE

Anticalcaire

EF-i32

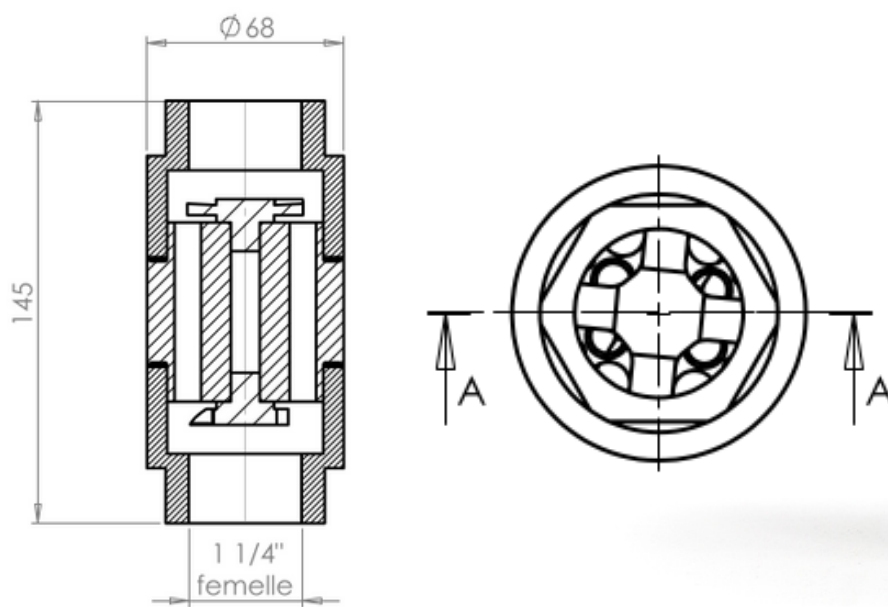

Référence	EF-i32
Matière du Corps	INOX 316L
Diamètre Nominal	DN32
Type de raccordement	Taraudage femelle fixe
Dimension du Raccordement	1"1/4
Capacité de traitement Maximal	98,3 l/min
Capacité de traitement Maximal	5,9 m3/h
Pertes de Charges à débit Maximal	220 mbar
Température Maximale	155°C
Température Minimale	-20°C
Pression Maximale	25 bars
Longueur Totale	145 mm
Diamètre Extérieur	68 mm
Poids	2,3 kg

